

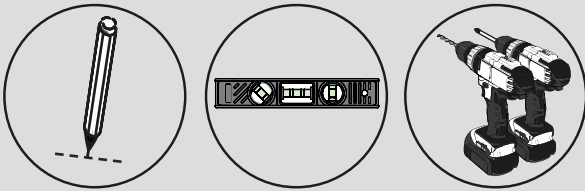

Guaranteed
for
20
yrs

AKW[®]
life. style. choice.

SureForm Wet Floor Former





Installation Instructions & User Care Instructions

 Suitable for concrete or wooden floor installations

 Formers are NOT trimmable

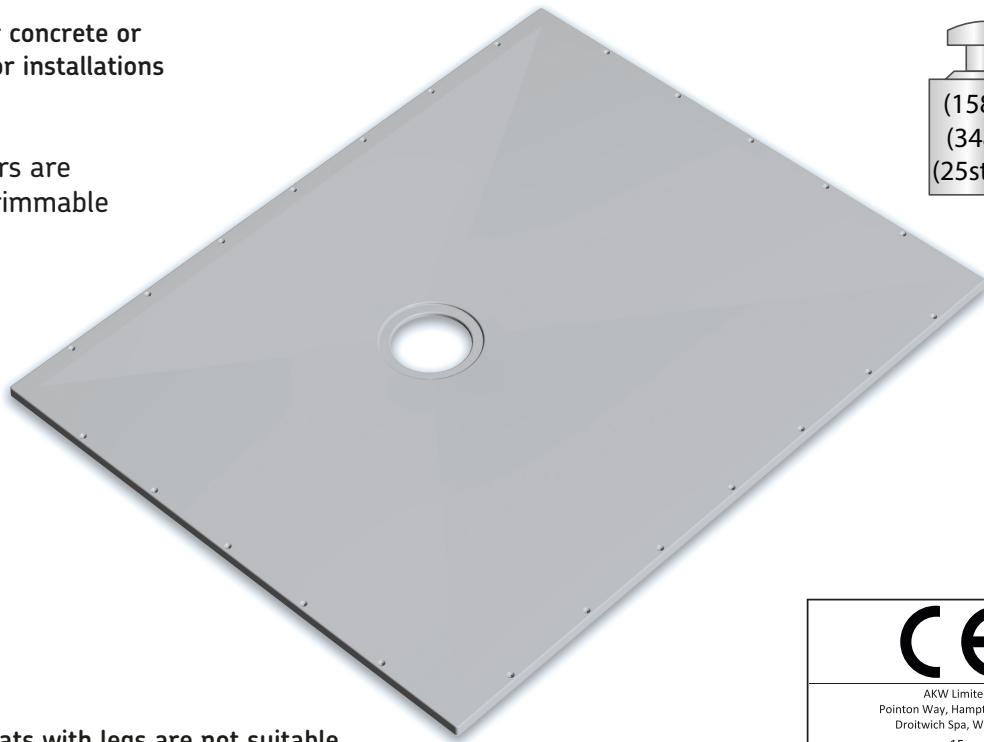
(158kg)
(348lb)
(25stone)



 Shower Seats with legs are not suitable

CE

AKW Limited
Pointon Way, Hampton Lovett
Droitwich Spa, WR9 0LR
15
DoP 14-021-010
PH
EN 14527: 2006+A1: 2010
CL1+CL2

Installer- please read all instructions carefully before installation
and leave these instructions with the end user for future reference

AKW[®]
life. style. choice.

SureForm - Wet Room Shower Former Range

Guaranteed for **20** yrs

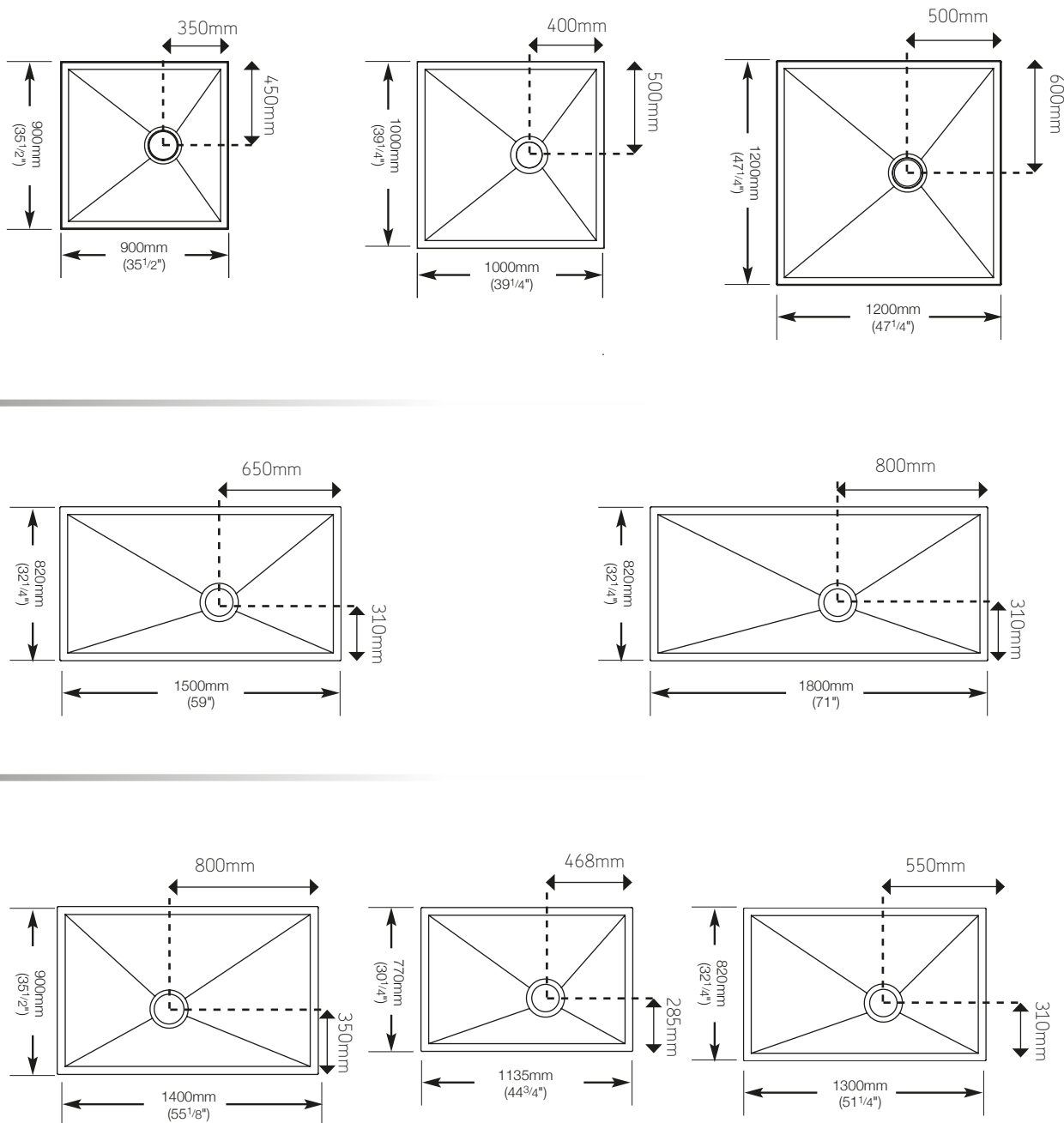

SureForm



By rotating the rectangular formers by 180° the waste position location can be moved to avoid the joists

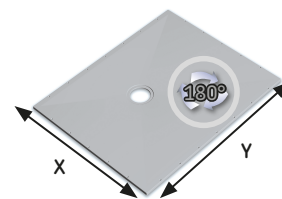

Be careful of pipe work or underfloor cables as risk of shock can be present.
 Turn off the mains electric supply before starting any work.
 Never use power tools if you are standing in water or on a wet surface.
 Caution when using power-tools indoors and in wet room areas can be still be dangerous.
 Only use cordless power tools that are double insulated.



For further information please visit:

<http://www.akw-ltd.co.uk/catalogue-downloads/videos/installation-videos/>

SureForm – Assembly and important information

i SureForm is designed for solid floor and wooden floor installations.

Please ensure that you read these instructions in full before commencing work.

The SureForm wet floor former is designed to be installed into concrete floors or into wooden floors supported by a reinforced sub floor or additional noggins and then either tiled over or used with a safety floor covering. If tiling SureForm is designed to work with a waste drainage system and a waterproofing membrane tanking system. SureForm accommodates many different waste options - TF75 (25106 or 25408) / TFWA+GW19 (25129) / TFWA+GW50 (25124) / TFWA adaptor only (25107) / Low Depth GW90 & adaptor (25404+25409) / Silentflow+ (25414) or PGTF (25101) used for vinyl or safety flooring. SFWA (25433) / SS-TF75 (LB00101) / SS-TFWA+GW19 (LB00103) / SS-TFWA+GW50 (LB00102) / SS-TFWA adaptor only (LB00171) or SS-PGTF (LB00104) used for tiled floors. Stainless Steel Waste Adaptors include 2 different adaptor rings to suit most tile heights, ensure your waste option is suited to your installation. For more information see our full product catalogue.

When installing your SureForm former you should consider your desired wet room layout, the position of the supporting floor joists and the waste pipe exit route. The SureForm former has an offset waste so it can be rotated 180° degrees so that the waste area position location can be moved to avoid any joists or pipe runs. This will allow you to install the waste into the spaces between the floor joists or most suitable area of solid floor and achieve your wetroom layout.

The waste unit must be fully supported on all four sides with additional joists/noggins within 110mm the centre of the waste outlet position to support the waste area. Ensure to make provision for the waste outlet pipe exit route and elbow in one of the noggins supporting the waste area. Do not cut into the joists/noggins from above.

SureForm Formers are NOT trimmable.

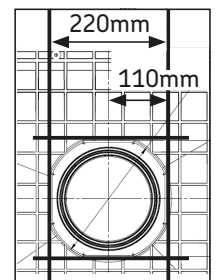

If installing with a floating floor construction ensure the SureForm former is still fully supported with additional joists/noggins on all 4 sides and with supports at 350–400mm centres. The waste outlet area must be also supported to within 110mm from the centre of the waste outlet position. Ensure the floating floor construction is level and any insulating materials are replaced between the load bearing members. Slippage or lifting during installation on a concrete floor is eliminated by the honeycomb underside which allows the tray to key into soft cement or screed.

If tiling you will need to consider which waterproofing membrane treatment you are going to apply to the floor and walls in your wet area. AKW recommend FormSafe® or Mapei® waterproofing membrane tanking kit systems which has been specifically designed to work with all our formers when lightly abraded. Ensure the rest of the wetfloor showering area is level with the height of the former, traditionally this has been done by adding a plywood sub-floor underlay or backer board to support tiling. Only when SureForm is level with the surrounding floor can a waterproof barrier such as FormSafe® or Mapei® can be applied and then covered with tiles. Follow separate waterproofing system instructions for further details.

Safety flooring for wet areas is an anti-slip flooring surface. It is specifically designed for safety with wet, bare feet or soft soled footwear, ideal for showering wet rooms. Safety flooring must be installed using appropriate adhesive on a smooth, dry and suitable substrate with the former lightly abraded before applying the adhesive.

The thermal insulating properties of SureForm are ideal for the addition of electric underfloor heating which can be installed over the shower former. If you are going to cover your existing floor with underfloor heating you will need to allow for this increase in the finished height of the surrounding floor during installation. Adjust the heights of the reinforcing sub-floor and the platform that it is installed on so that the edges of the installed former finish flush with the rest of your reinforced underlaid bathroom flooring.

Shower Seats with feet are not suitable and must not be used with this SureForm former. When correctly installed in accordance with these instructions and finished with a tiled floor your SureForm wetroom former will be suitable for 25stone / 158KG user.

Failure to install this AKW product in accordance with supplied instructions or the making of unauthorised modifications will invalidate any warranty and will affect product safety.

AKW Guarantee your wet floor former for 20 years from the date of purchase.

Screeded Floor Installation Instructions

SureForm Gravity Waste Options - PGTF / SS PGTF / GW50 / GW19 / TFWA

Depth below formers: SilentFlow+PGTF 22mm= 51mm - PGTF 15mm=35mm - GW19=97mm - GW50=128mm

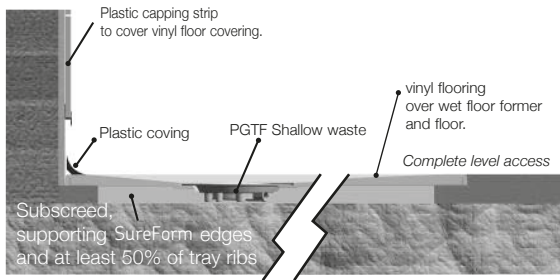

Step 1. Position the SureForm over the desired location for the shower. Formers are trimmable and can be cut to down to minimum 150mm to the waste area. Ensure the cut edges are straight and put towards the wall mounted side. If necessary cut to the correct size with a suitable circular saw or a fine toothed blade. Mark around the edge of the shower former.

Step 2. Remove the existing flooring and dig out building materials to the wet floor former area. Always wear protective equipment.

Step 3. Route waste outlet and remove any building materials such as concrete to allow waste pipe to reach an outside gully. For example a TFWA +GW50 requires 128mm depth under the former to allow for installation. For SilentFlow+ PGTF 22mm PGTF upto 51mm depth is needed for the sump

dish. Use a high quality pipe system for all buried connections. Always follow separate waste installation instructions and for pumped wastes always fit JohnGuest "C" clip. Connect the waste drain to the outlet pipe and clear away all excess adhesive. Ensure the bottom of the waste is supported and secure the waste drain or PGTF sump dish in place. Test for leaks.

Step 4. Remove all loose materials. Add the level screeded floor, covering all of the former area. The SureForm must be fully supported on all four edges and evenly over at least 50% of the honeycomb underside. The waste must be fully supported within 110mm the centre of the waste outlet position. Do not "Dot & Dab" as the supporting surface must be level. Sand and cement may be used to create a subscreed at least 22mm lower than the finished floor height. Allow this mix to set. Flexible sand & cement mix may then be applied liberally to the subscreed to hold the former firmly in position at installation. Do not use foam or plaster as a load bearing support as it will break down under repeated use.



Secure in place and connect the waste outlet. Always clear away all excess adhesive. Support the bottom of the waste.

Step 5. The edges of the SureForm must finish flush and level with the top of the finished screed top surface which should also be level. Ensure the fall is correct and the former is level before allowing to dry.

Step 6. The waste hole should be covered to protect it from any dirt or debris. Lightly abrade top surface and then clean. This will allow for the tanking system to achieve the best bond to the former. Allow for the curing time and ensure the screed floor is set hard before installing the tanking kit. **Not suitable for shower seats with legs and feet.**

Install the waterproof tiled floor tanking system over the SureForm, as per manufacturer guidelines.

Allow 24hrs after installation and tiling before showering.

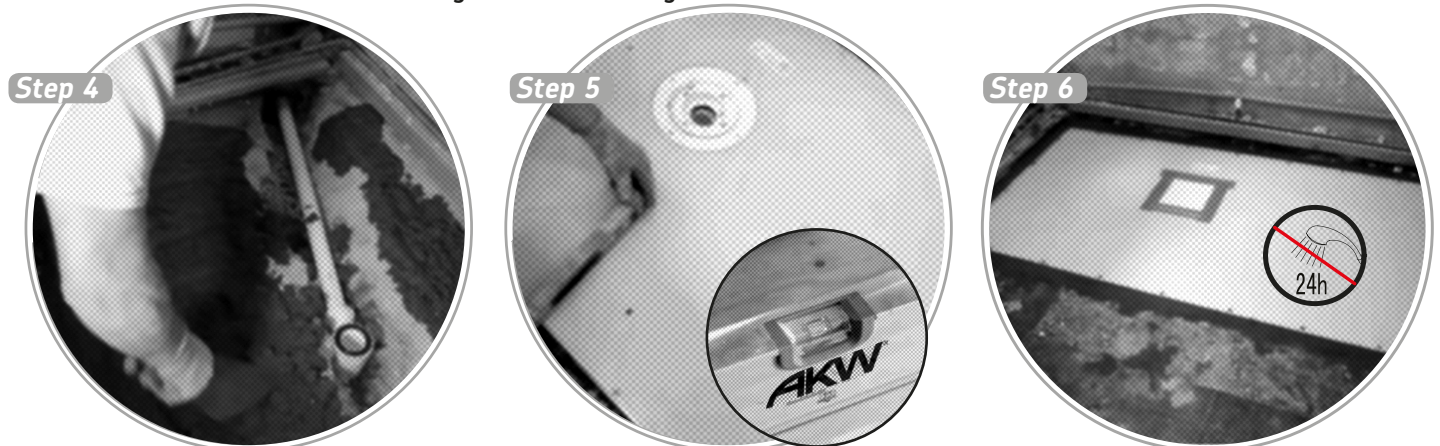

Wooden Floor Installation Instructions

SureForm Waste Options- PGTF / SS PGTF / TF75 / GW50 / GW19 / TFWA

Depth below formers: SilentFlow PGTF 22mm= 51mm - PGTF 15mm=35mm - GW19=97mm - GW50=128mm

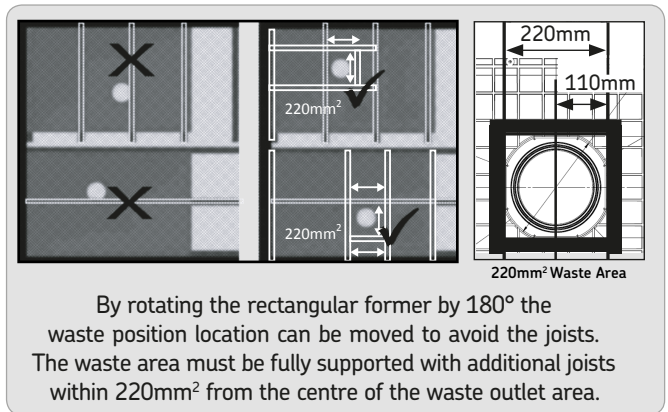
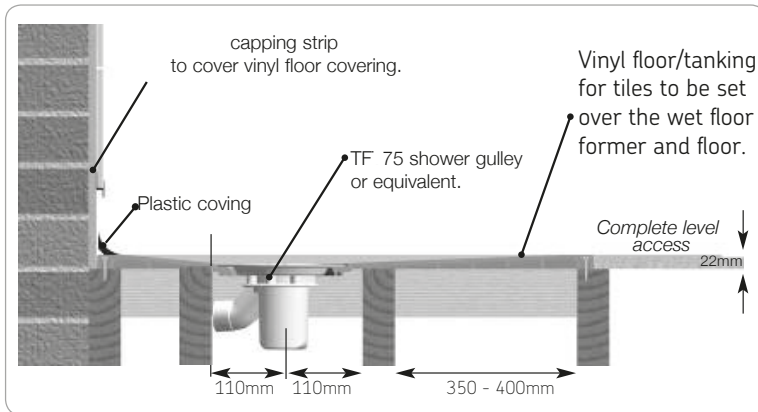

Step 1. Position the SureForm over the desired location for the shower and mark around the edge of the shower former. Align the SureForm into position and check for waste outlet entry. To avoid or minimise joist overlap, the SureForm former waste location is offset and it can be rotated 180° to allow the waste to fit between the joists.

Step 2&3. Cut out the flooring area within the marked area taking care not to cut through supporting joists or any electric wiring which may be below and remove the floor boards. Ensure the cut edges are straight and wear protective equipment when handling power tools. **Align the SureForm into position and check for waste outlet entry** - to avoid or minimise joist overlap, the SureForm waste location is offset. Rotate the SureForm either 180° to allow the waste to fit within the joists.

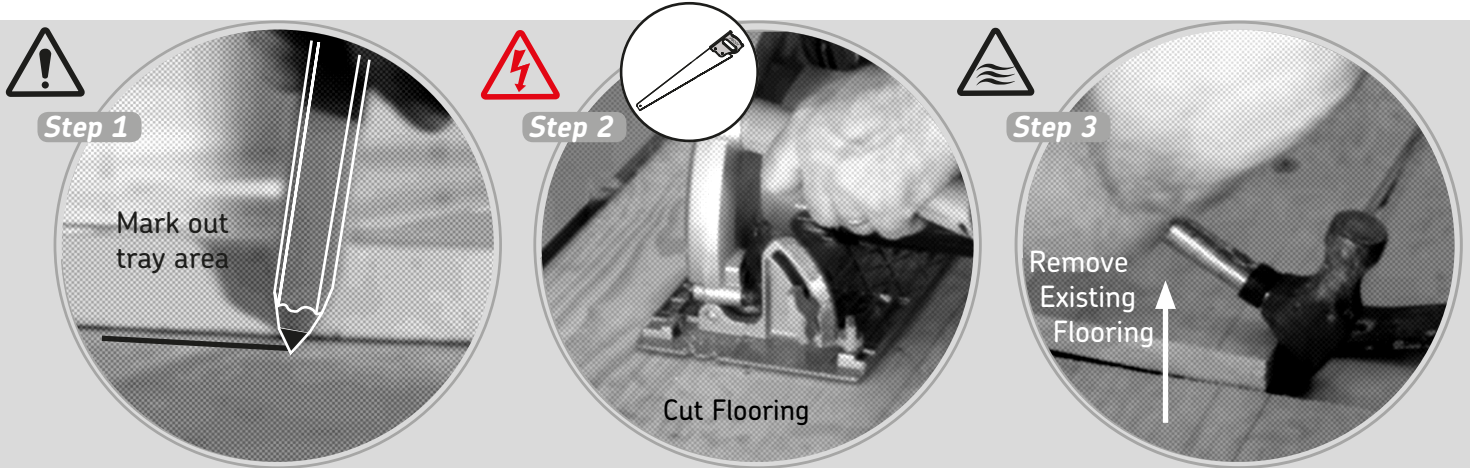

Step 4. Place new Joists/Noggins 75mm x 50mm (3"x 2") to all the supporting edges of the cut-out area to provide support for both the SureForm former and the existing floor edge. The 50mm (2") wide supporting joists must be on 350-400mm (14-16") centres maximum apart. Please note that the top surfaces of the joists/noggins do not require profiling for this flat-bottomed former.

Step 5. The waste outlet area subframe must be 220mm² supporting the former on all four sides with additional noggins 110mm from the centre of the waste outlet position. Make provision for the waste outlet pipe and elbow in one of the noggins supporting the waste outlet area.

Step 6. Mark and measure the waste outlet pipe position for the shower tray. Support the bottom of the waste trap.

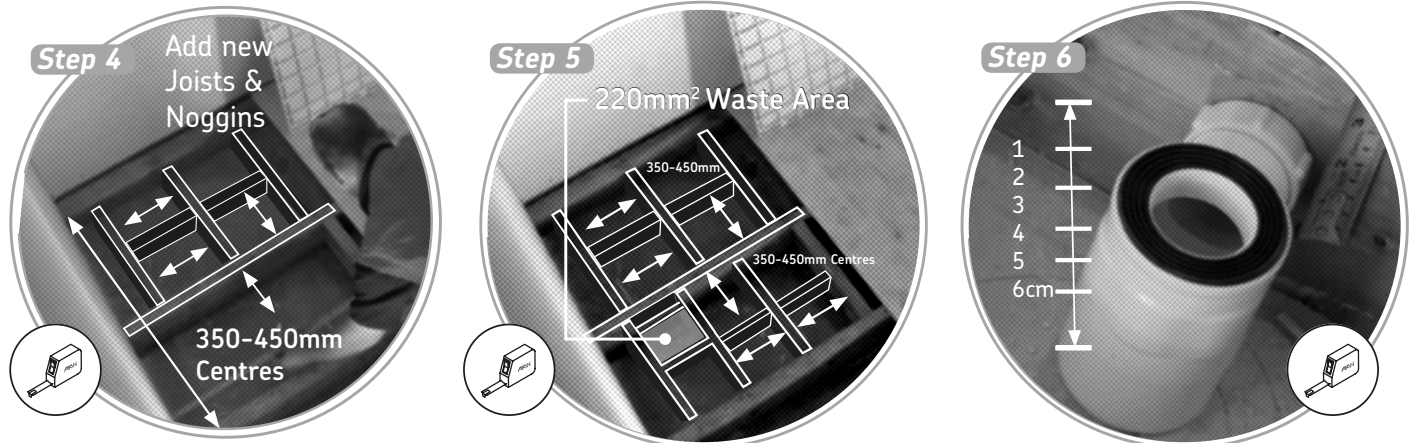

Wooden Floor Installation Instructions

Step 7. Only use a rotary hole cutter to drill through the joist or noggins. Do not cut or saw into the joists from above. Insert the pipework through the joists or noggins and align to the waste drain outlet pipe.

Step 8. Insert pipework through the joists and noggins and align to the waste drain outlet pipe. **Note: The waste area must be fully supported by additional joists and noggins within 220mm² around the waste drain. Ensure the base of the drain outlet is supported.**

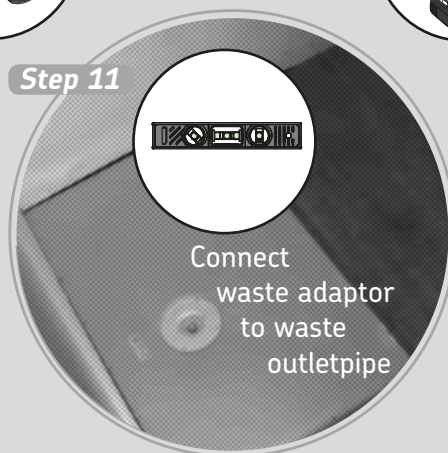
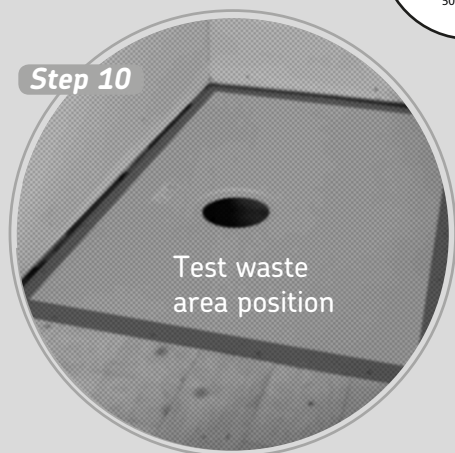
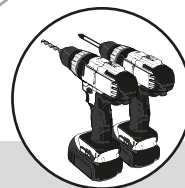
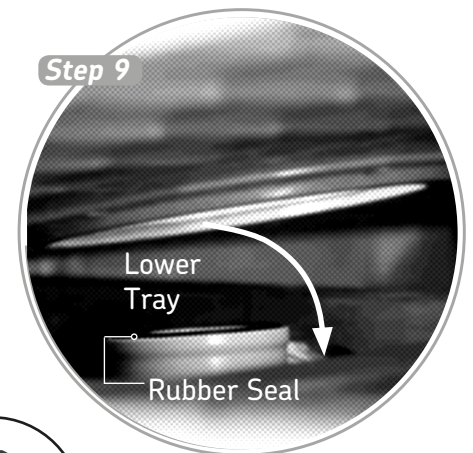
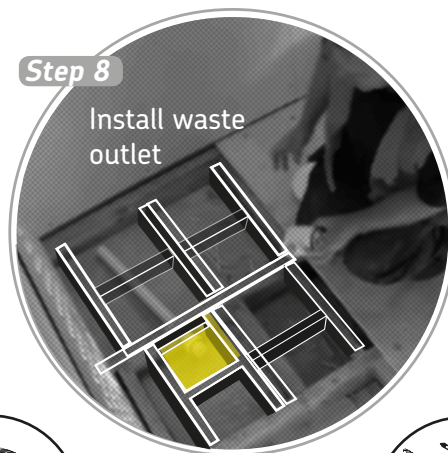
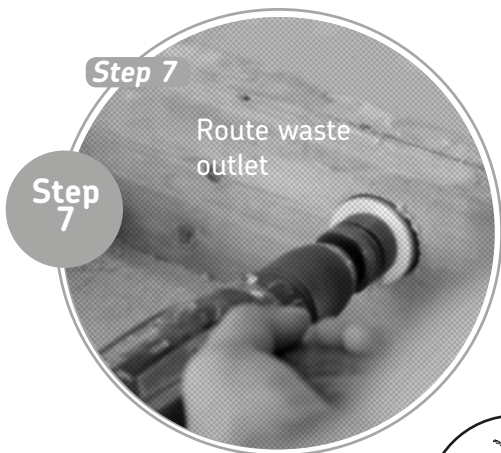
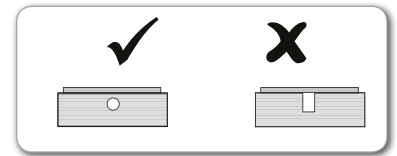

Connect the waste drain to 1½" waste outlet pipe and test for leaks by pouring water into drain to ensure it is water tight as it will not be possible to return to it once the former has been installed. Ensure the rubber seal is fitted to the top of the waste. Ensure the base of the waste is fully supported. Check that the top of the waste is in line with the top of the joists.

Step 9,10&11 Test fit the shower former to ensure a tight fit and the alignment of the waste and the drain.

Step 12. Fit the SureForm waste adaptor to the shower former. See separate SureForm waste adaptor installation instructions for further details to connect the waste to the former.

Smear a fine bead of silicone around the underside rim of the adaptor before securing into place and clear away all excess adhesive and silicone sealant.

Secure to the former by drilling 2½ mm pilot holes. Screw the waste adaptor to the former securely using the 4 x CSK Head screws. Ensure the screw heads are flush and do not protrude or they may cut into the wet floor drain gasket seal.

Wooden Floor Installation Instructions

Example of Waste Installation

Step 13

Tiled Flooring

Gravity Waste- GW19 /GW50

Depth below former: 97mm for GW19 - 128mm for GW50

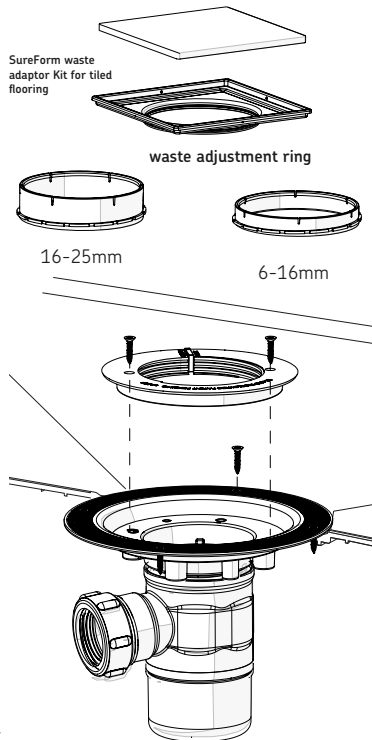

Safety Flooring

Gravity Waste- TF75

Depth below former: 125mm

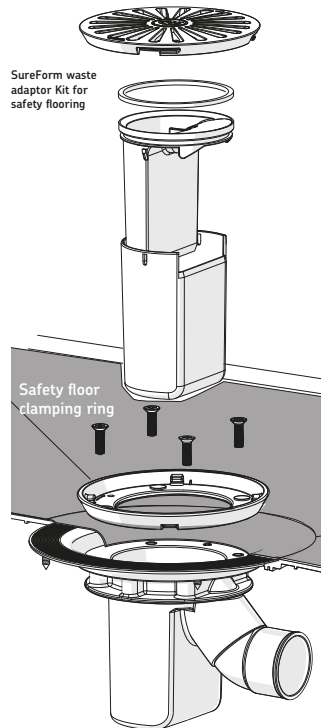

Step 13. Different types of waste can be used for tiled floors or safety flooring. Follow separate instructions.

Note: All types and sizes of tile thicknesses can be used if the threaded adjustment ring is adjusted to the desired height. Depending upon the thickness of the floor tiles to be used, change the threaded adjustment ring, large or small. (Large = 16-25mm (5/8"-1in) (Small = 6-16mm (1/4"-5/8" in)).

Step 14. Fix the waste adaptor or clamping ring securely to the former and ensure all fixing holes are used and it is locked into position. Ensure the screw heads are flush and do not protrude or they may cut into the wet floor drain gasket seal or could damage the safety flooring. Fit the waste trap and waste drain cover securely and lock into position.

Step 15. Set levels -

(Floor surface to SureForm mounting surface is 22mm)

The edges of the former should be checked with a spirit level. If the surrounding floor is lower than the SureForm, use a plywood sub-floor overlay ply to bring the surrounding floor levels up to the SureForm. Ensure the fall is always to the waste outlet. If the surrounding floor is higher than the SureForm, use plywood on all exposed joists and noggins to bring the former level to the surrounding floor levels.

Step 14



Step 15



Step 16

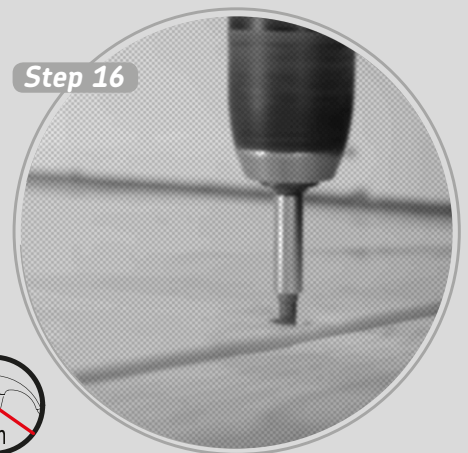

Step 16. Fix down - only when the former is fully supported and level with the surrounding floor, apply an adhesive or mastic to all supporting surfaces and screw down the edges of the former onto the joists and noggins. Foam should not be used as a load bearing support as it will break down under repeated product use. Do not overtighten the screws.

Additional screws can be added in any part of the former to remove any flexing should it occur.

The screw-holes have moulded blanks which must be drilled out (5mm (1/4" dia) before fitting screws.

Use a minimum of 2 or 3 screws per side - a large number of screw holes have been provided to assist locating the former - you do not have to use them all. Fill any unused screw holes and ensure all the screw heads are flush with top face of former.

Lightly abrade top surface and then clean. This will allow for the tanking system to achieve the best bond to the former.

Install a waterproof tanking system before adding tiles. Not suitable for shower seats with legs and feet. Continue to cover in a waterproof and thermally insulated barrier tanking system such as AKW FormSafe® and follow the separate instructions, ensuring each process is carried out according to the manufacturer's guidelines.

The waste hole should be covered to protect it from any dirt or debris. **Allow 24hrs after tiling before showering.**

Important Safety Information

ALWAYS



Read these installation instructions carefully before installing this product and leave with the end user for future reference.

ALWAYS



Have the former installed by a trained and experienced installer.

ALWAYS



Support the waste with additional joists. Evenly support the edges of the former when installing into the floor. Weight must be evenly spread across the former.

NEVER



Exceed the spreadable weight capacity of 25 stone (158Kg) on a finished tiled floor.

NEVER



Use shower seats with feet with this former. Do not stand on the shower former before the former has finally set/cured and finished with tiles. This will effect the fall of the water drainage to the shower waste.



Caution



Check for electric cables and water pipework before cutting into floor boards or drilling into surfaces.

Beware

A pinch hazard may be present around the edges during installation.

Orderline

01685 898110

Website

www.wetroomsdirect.net

Enquiries Email

sales@wetroomsdirect.net



For the latest AKW product news scan this QR code with your device.

*Guarantee

Not covered by any warranty

Guaranteed
for
20
yrs

The guarantee applies only to manufacturing or material defects and does not apply to normal wear and tear, inappropriate use or accidental damage. This does not cover damage or defects that result from incorrect installation, improper use, accidental damage or lack of maintenance including the build up of grime, dirt or lime-scale and water-borne debris or damage from point weight loading such as shower seat feet. Damage resulting from inappropriate cleaning or water ingress. Damage or defects that result from repairs, modifications undertaken by unauthorised persons who are not maintenance engineers.

What to do if something goes wrong?

In the unlikely event that you should encounter a problem with this product, please contact your local installer and if this does not resolve the issue then contact AKW technical team who will provide further advice and if necessary arrange for a maintenance engineer to visit and report any issues. As part of our quality and training program calls may be monitored or recorded. None of the foregoing affects your statutory rights.

These instructions are provided to advise the minimum standards of installation and recommends what is the best practice for the installation. Due to the very wide variability of possible installation conditions AKW cannot provide all circumstances for the installation. AKW cannot accept any liability in connection with this information or its use. This information is provided on the condition that the person receiving it shall make their own tests to determine the suitability for their particular purpose. Failure to install this AKW product in accordance with supplied instructions or the making of unauthorised modifications will invalidate any warranty and may affect product safety. None of the foregoing affects your statutory rights.

www.wetroomsdirect.net